



ATH-ANC900BT

User Manual
Wireless Noise-Cancelling Headphones



Introduction

Thank you for purchasing this Audio-Technica product.

Before using the product, please read through the Quick Start Guide and Caution Guide, as well as this user manual when necessary, to ensure that you use the product correctly.

Safety precautions

Although this product was designed to be used safely, failing to use it correctly may result in an accident. To ensure safety, observe all warnings and cautions while using the product.

Cautions for the product

- Do not use the product near medical equipment. Radio waves may affect cardiac pacemakers and medical electronic equipment. Do not use the product inside medical facilities.
- When using the product in aircraft, follow airline instructions.
- Do not use the product near automatic control devices such as automatic doors and fire alarms. Radio waves may affect electronic equipment and cause accidents due to malfunction.
- Do not disassemble, modify or attempt to repair the product to avoid electric shock, malfunction or fire.
- Do not subject the product to strong impact to avoid electric shock, malfunction or fire.
- Do not handle the product with wet hands to avoid electric shock or injury.
- Disconnect the product from a device if the product begins to malfunction, producing smoke, odor, heat, unwanted noise or showing other signs of damage. In such a case, contact your local Audio-Technica dealer.
- Do not allow the product to get wet to avoid electric shock or malfunction.
- Do not put foreign matter such as combustible materials, metal, or liquid in the product.
- Do not cover the product with a cloth to avoid fire or injury by overheating.
- Follow applicable laws regarding mobile phone and headphone use if using headphones while driving.
- Do not use the product in places where the inability to hear ambient sound presents a serious risk (such as at railroad crossings, train stations, and construction sites).
- When charging, make sure to use the included USB charging cable.
- Do not charge with devices that have quick-charge functionality (with a voltage of 5 V or more). Doing so may cause the product to malfunction.
- To prevent damage to your hearing, do not raise the volume too high. Listening to loud sound for an extended period may cause temporary or permanent hearing loss.
- Discontinue use if skin irritation results from direct contact with the product.
- Do not catch your fingers or other body parts between the housing and the arm or inside the joints.

Safety precautions

Cautions for rechargeable battery

The product is equipped with a rechargeable battery (lithium polymer battery).

- If battery fluid gets into eyes, do not rub them. Rinse thoroughly with clean water such as tap water and consult a doctor immediately.
- If battery fluid leaks, do not touch fluid with bare hands. If fluid remains inside the product, it may cause malfunction. If battery fluid leaks, contact your local Audio-Technica dealer.
 - If fluid gets in your mouth, gargle thoroughly with clean water such as tap water and consult a doctor immediately.
 - If your skin or clothing comes in contact with fluid, immediately wash the affected skin or clothing with water. If you experience skin irritation, consult a doctor.
- To avoid leakage, generation of heat or explosion:
 - Never heat, disassemble or modify the battery, nor dispose of it in a fire.
 - Do not attempt to pierce with a nail, hit with a hammer or step on the battery.
 - Do not drop the product or subject it to strong impact.
 - Do not get the battery wet.
- Do not use, leave or store the battery in the following places:
 - Area exposed to direct sunlight or high temperatures and humidity
 - Inside of a car under the blazing sun
 - Near heat sources such as heat registers
- Charge only with the included USB cable to avoid malfunction or fire.
- The internal rechargeable battery of this product cannot be replaced by the user. The battery may have reached the end of its service life if the usage time becomes significantly shorter even after the battery has been fully charged. If this is the case, the battery needs to be repaired. Contact your local Audio-Technica dealer for repair details.
- When the product is disposed of, the built-in rechargeable battery needs to be discarded properly. Contact your local Audio-Technica dealer to learn how to properly dispose of the battery.

For customers in the USA

FCC Notice

Warning

This device complies with Part 15 of the FCC Rules. Operation is subject to the following two conditions: (1) This device may not cause harmful interference, and (2) this device must accept any interference received, including interference that may cause undesired operation.

Caution

You are cautioned that any changes or modifications not expressly approved in this manual could void your authority to operate this equipment.

Note: This equipment has been tested and found to comply with the limits for a Class B digital device, pursuant to part 15 of the FCC Rules. These limits are designed to provide reasonable protection against harmful interference in a residential installation. This equipment generates, uses and can radiate radio frequency energy and, if not installed and used in accordance with the instructions, may cause harmful interference to radio communications. However, there is no guarantee that interference will not occur in a particular installation. If this equipment does cause harmful interference to radio or television reception, which can be determined by turning the equipment off and on, the user is encouraged to try to correct the interference by one or more of the following measures:

- Reorient or relocate the receiving antenna.
- Increase the separation between the equipment and receiver.
- Connect the equipment to an outlet on a circuit different from that to which the receiver is connected.
- Consult the dealer or an experienced radio/TV technician for help.

RF Exposure Statement

This transmitter must not be co-located or operated in conjunction with any other antenna or transmitter used in other systems. This device complies with FCC radiation exposure limits set forth for an uncontrolled environment and meets the FCC radio frequency (RF) Exposure Guidelines. This equipment has very low levels of RF energy that is deemed to comply without testing of specific absorption rate (SAR).

For customers in Canada

IC statement

CAN ICES-3 (B)/NMB-3(B)

This device complies with Industry Canada's licence-exempt RSSs. Operation is subject to the following two conditions: (1) This device may not cause interference; and (2) This device must accept any interference, including interference that may cause undesired operation of the device.

Under Industry Canada regulations, this radio transmitter may only operate using an antenna of a type and maximum (or lesser) gain approved for the transmitter by Industry Canada. To reduce potential radio interference to other users, the antenna type and its gain should be so chosen that the equivalent isotropically radiated power (e.i.r.p.) is not more than that necessary for successful communication.

This device complies with RSS-102 radiation exposure limits set forth for an uncontrolled environment.

Notes on use

- Be sure to read the connected device's user manual before use.
- Audio-Technica will not be liable in any way for any loss of data in the unlikely event that such losses should occur while using the product.
- On public transportation or in other public places, keep the volume low so as not to disturb other people.
- Minimize the volume on your device before connecting the product.
- When using the product in a dry environment, you may feel a tingling sensation in your ears. This is caused by static electricity accumulated on your body, not by product malfunction.
- Do not subject the product to strong impact.
- Do not store the product in direct sunlight, near heating devices, or in hot, humid, or dusty places. Additionally, do not allow the product to get wet.
- When the product is used for a long time, the product may become discolored due to ultraviolet light (especially direct sunlight) and wear.
- Make sure to hold the plug when connecting and disconnecting the USB charging cable. The USB charging cable may become severed or an accident may occur if you pull on the cable itself.
- When you are not using the USB charging cable, disconnect it from the product.
- If the product is placed in a bag while the USB charging cable is still connected, the USB charging cable may become caught, severed, or broken.
- When you are not using the product, store it in the included case.
- This product can be used to talk on the phone only when using a mobile telephone network. Support for telephony apps that use a mobile data network is not guaranteed.
- If you use the product near an electronic device or transmitter (such as a mobile phone), unwanted noise may be heard. In this case, move the product away from the electronic device or transmitter.
- If you use the product near a TV or radio antenna, noise may be seen or heard in the television or radio signal. In this case, move the product away from the TV or radio antenna.
- To protect the built-in rechargeable battery, charge it at least once every 6 months. If too much time passes between charges, the life of the rechargeable battery may be reduced, or the rechargeable battery may no longer be able to be charged.
- The volume of the product differs depending on if the noise-cancelling function is on or off.
- Operating with a sharp-tipped object, such as a ballpoint pen or pencil, may not only result in incorrect operation, but could also damage or break the touch panel.
- Do not touch the touch panel with the very tip of your finger. Doing so may cause your fingernail to break.
- If the product does not operate at all or as intended when touched, check to make sure that your other fingers, parts of your hand, or clothing are not in contact with the product when touching. Confirm the touching range of the touch panel with the user manual before operating its wide range by touching. Also, the product may not operate correctly if you are wearing gloves or if your fingertips are dry.
- The product may not operate correctly if the touch panel is dirty from sweat. Remove any dirt before operating the product.
- The provided airplane adapter may not be compatible with certain types of aircraft devices.
- Do not use the product when the use of electronic devices is prohibited on the airplane, or when the use of personal headphones with the aircraft's audio service is prohibited.

About the active noise-cancelling function

The product is designed to use its built-in microphone to pick up noise from the surrounding environment (noise from vehicles, noise from air conditioners, etc.) and to cancel out that noise by producing sounds in negative phase. This results in a reduction in the sounds in your environment.

- The product's noise-cancelling function mainly reduces noises of 300 Hz or lower. Because of this, it has almost no effect on noises above that frequency (ringtones, speaking voices, etc.).
- Not all sounds are cancelled.
- Depending on the type of noise (or in quiet locations), you may not notice the noise-cancelling effect.
- There is a "humming" sound when you turn on the noise-cancelling function. This is the sound of the noise-cancelling function operating; it is not a malfunction.
- The noise-cancelling effect may vary or a bleep (howling) may occur depending on how you wear the product. In these cases, take off the product and put it on again correctly.
- When you use the product in a train or a car such as bus or truck, noise may be heard depending on rail/street conditions.

For a more comfortable Bluetooth® communication experience

The effective communication range of this product varies depending on obstructions and radio wave conditions. For a more enjoyable experience, please use the product as close as possible to the Bluetooth device. To minimize noise and sound disruptions, avoid placing your body or other obstacles between the product's antenna (L side) and the Bluetooth device.

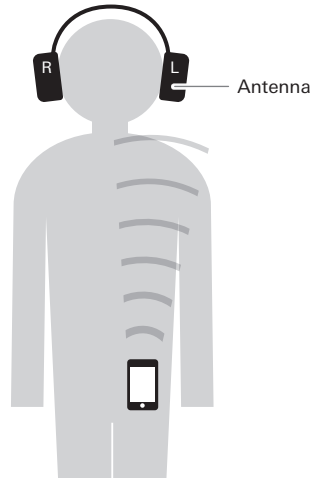

Part names and functions

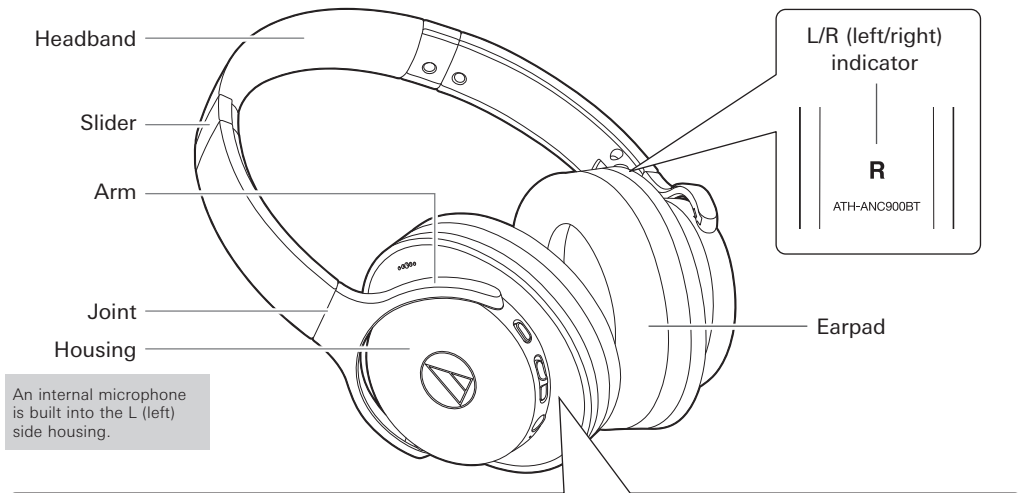

An internal microphone is built into the L (left) side housing.

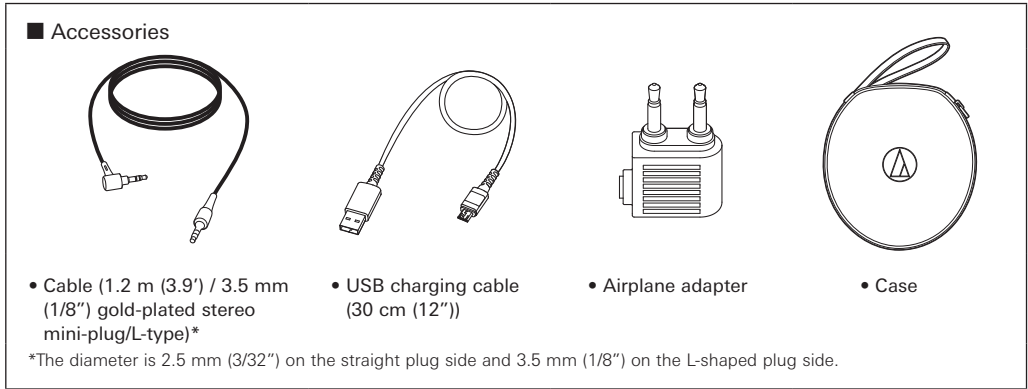
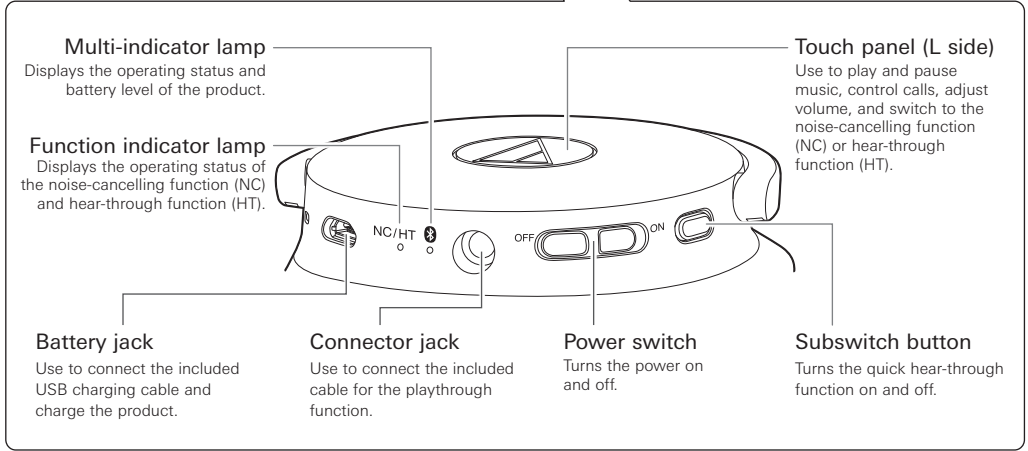

Charging the battery

- Fully charge the battery when using for the first time.
- When the rechargeable battery is running low, the product will make a sound through the headphones, and the multi-indicator lamp will flash in red. In this case, charge the battery.
- It takes about 5.5 hours maximum to charge the battery fully. (This time may vary depending on usage conditions.)
- While charging the battery, the product's Bluetooth connection remains disabled and therefore the product's Bluetooth feature cannot be used.

1. Connect the included USB charging cable (Micro USB Type-B side) to the battery jack.
 - The included USB charging cable is designed for exclusive use with the product. Do not use other cables to charge the product.
 - When inserting the USB charging cable into the USB port or battery jack, check that the connector is facing in the correct direction before inserting it directly (horizontally).

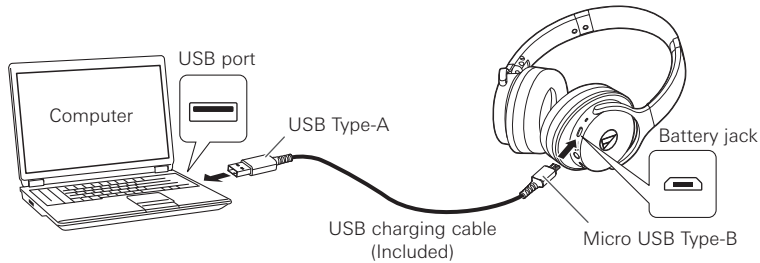

2. Connect the included USB charging cable (USB Type-A side) to the computer to start charging.
 - While charging, the multi-indicator lamp lights as follows (it may take several seconds for the multi-indicator lamp to light).
Lit in red: Charging
Off: Charging complete
3. When charging is complete, disconnect the USB charging cable (USB Type-A side) from the computer.
4. Disconnect the USB charging cable (Micro USB Type-B side) from the product's battery jack.

- If you start to charge while the product is on, it will turn off while charging. When charging is complete, turn off the power switch and then turn it on again.
- When charging, make sure to use the included USB charging cable. The product may not charge with cables other than the included USB charging cable.
- You cannot use this product to listen to music while it is charging.

Connecting via Bluetooth wireless technology

To connect the product to a Bluetooth device, the product needs to pair (register) with the device.

Pairing a Bluetooth device

- Read the user manual for the Bluetooth device.
 - Place the Bluetooth device within 1 m (3.3') of the product to perform pairing correctly.
 - To confirm the progress of the pairing process, wear the product while performing this procedure and listen for the confirmation tone.
1. Starting with the product turned off, slide the power switch to the "ON" position.
 - The multi-indicator lamp will light in white, and then flash in white.
 2. Use your Bluetooth device to begin the pairing process and search for the product.
When your Bluetooth device finds the product, "ATH-ANC900BT" will be displayed on the device.
 - For information about using your Bluetooth device, refer to the device's user manual.
 - This product may be displayed as "ATH-ANC900BT", "BLE_ATH-ANC900BT", or both. If both are displayed, select "ATH-ANC900BT". If only one is displayed, select that one.
 3. Select "ATH-ANC900BT" to pair the product and your Bluetooth device.
 - Some devices may ask for a passkey. In this case, enter "0000". The passkey may also be called a passcode, PIN code, PIN number, or password.
 - The product sounds a confirmation tone when pairing is complete.
 - Pairing a second device or more may take some time. In such cases, wait until the multi-indicator lamp (p.15) indicates "pairing" .



About pairing

When connecting a new Bluetooth device, you need to pair it with the product. Once the Bluetooth device and the product are paired, you do not need to pair them again. The product supports multi-pairing, in which a connection history is saved.

However, in the following cases you will need to pair again even if the Bluetooth device was paired once:

- If the product is deleted from the Bluetooth device's connection history.
 - If the product is sent out for repair.
-
- When switching to a Bluetooth device, you may not be able to pair because the previously connected Bluetooth device cannot be disconnected. In such cases, long touch (10 seconds) the upper and center parts of the touch panel as shown in the figure. The product will switch to the "searching for devices" state and you will be able to pair with your desired Bluetooth device.

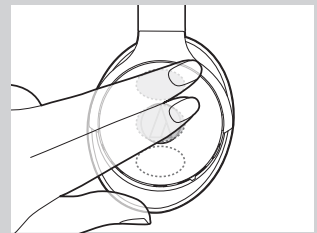

Using the product

The product can use Bluetooth wireless technology to connect to your device and play music, receive phone calls, etc. Use the product for whichever of these purposes suits your needs.

Note that Audio-Technica cannot guarantee the operation of displays, such as the battery level display, or applications via Bluetooth devices.

Power supply ON/OFF

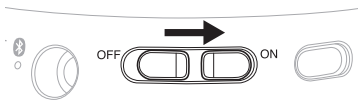
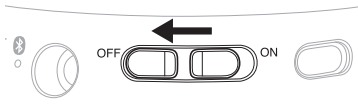
Power supply	Power switch operation	Multi-indicator lamp
ON		Lights in white, then flashes in white*1 *2
OFF		Lights in white, then turns off*2

*1 It may take several seconds for the multi-indicator lamp to light.

*2 For details, refer to "Multi-indicator lamp display" (p.15).

- If the product is on and not connected to a device after 5 minutes, the Bluetooth connection is disabled automatically. However, the ambience control (p.11) stays on. Also, if the product is on and you are using the playthrough function (p.13), the product will not turn off.

Wearing the product

Place the side of the product marked "L" (LEFT) over the left ear and the side marked "R" (RIGHT) over the right ear, slide the slider up or down so that the earpads cover your ears, and then adjust the headband.

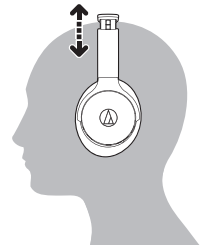

Using the product

Swivel mechanism

You can fold the housing so that it lies flat.

- The swivel mechanism cannot rotate more than 90 degrees. Do not apply excessive force.

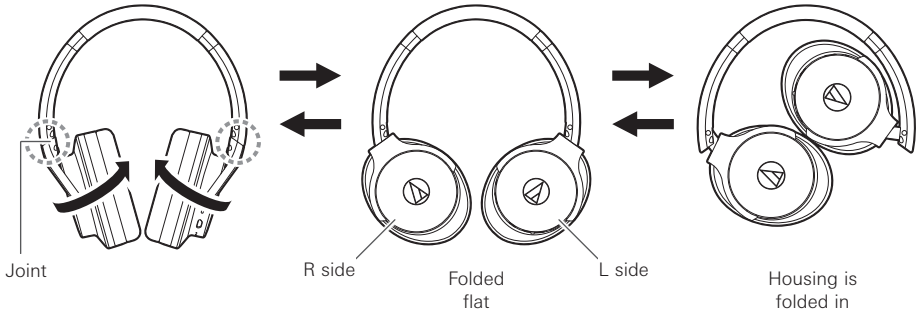

Compact folding

You can fold the housing into the inner side of the headband using the joints at the fulcrum.

- When folding the product, remove the included cable.
- Be careful so as not to get your fingers caught in the joints.
- When using the product, make sure to return the housings to their original positions.

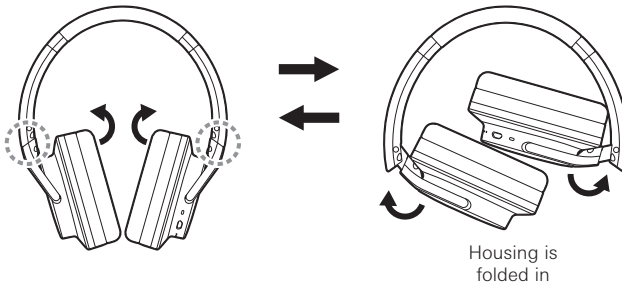



Using the product

Listening to music

- To connect for the first time, pair the product and your device via Bluetooth wireless technology. If you have already paired the product and your Bluetooth device, turn on the Bluetooth device's Bluetooth connection before turning on the product.
- Use your Bluetooth device to start playback, referring to the device's user manual as necessary.
- The L (left) side housing is a touch panel and has three touch locations at the upper, center, and lower part.

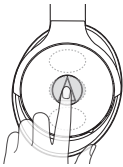
Touch panel (L side housing)

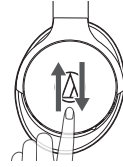
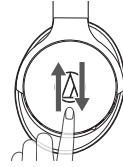
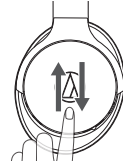
Operation	Function
	Touch Plays or pauses music. *1
	Long touch (2 seconds) Depending on the connected device, activates the device's speech recognition function (such as Siri for compatible iOS devices).
	Touch Increases the volume by 1 level. *2
	Touch Decreases the volume by 1 level. *2
	Swipe up Plays the next track. *1
	Swipe down Plays the previous track. *1

*1 Some controls may not be available for music playback on some smartphones.

*2 A confirmation beep will sound each time you touch the touch panel. A high beep or low beep is heard when the volume is at the maximum or minimum level respectively.

- The volume control of some devices may not work well with the product.

Using the product

Switching ambience control

The product features ambience control, in the form of a noise-cancelling function (called noise cancelling hereafter) and a hear-through function (called hear-through hereafter), which reduces or enhances outside noise.

You can switch the functions as follows by long touching (2 seconds) so that your palm covers the upper, center, and lower parts of the touch panel when the product is on.



- Ambience control returns to noise cancelling ON next after OFF.
- Noise cancelling is set by default.
- When using ambience control, the function indicator lamp lights as follows.

Lit green: Noise cancelling ON/Hear-through ON

Off: Noise cancelling and hear-through OFF

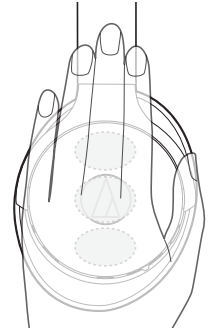

Noise cancelling

The microphone built into the product detects ambient noise, and outputs a sound-cancelling signal to effectively reduce noise.

- When you use the product for the first time and turn it on, noise cancelling turns on automatically.
- There is a difference in volume when noise cancelling is on and off.

Hear-through



This function allows you to hear surrounding sound via the built-in microphone while you listen to music.

- Occasionally it may be difficult to hear surrounding sound depending on the volume of the music, etc. that you are playing. In such a case, turn down the volume of the music, etc.
- Even when you use this function, the surrounding sound may be difficult to hear depending on the surrounding situation, etc. Do not use this product in locations where it may be dangerous if you cannot hear surrounding sound, such as places with heavy traffic, etc.

Using the product

Talking on the phone

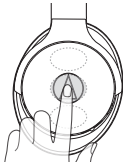
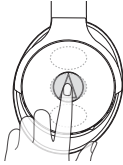
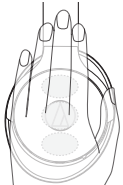
- If your Bluetooth device supports telephone features, you can use the microphone built into the product to talk on the phone.
- When your Bluetooth device receives a phone call, the product sounds a ring tone.
- If a call is received while you are listening to music, music playback is paused. When you finish the call, music playback resumes. *1

When	Operation		Function
Receiving a call		Touch	Answers the call.
		Long touch (2 seconds)	Rejects the call.
Talking on a call		Long touch (2 seconds)	Ends the call.
		Long touch (2 seconds) the upper, center, and lower parts	Each time you long touch (2 seconds), you switch the call to your mobile phone or to the product. *2
		Touch	Increases the call volume by 1 level.
			Decreases the call volume by 1 level.

*1 Depending on your Bluetooth device, music playback may not resume.

*2 When you hear a confirmation tone, release your hand from the touch panel.

- The phone call controls explained above may not be available on some smartphones.

Using the product

Quick hear-through function

This function enhances external sound by focusing on people's voices. The volume of music being played back decreases automatically.

It is useful for when you want to listen to public transportation announcements or people's voices.

1. Press the subswitch button.
 - When the quick hear-through function is on, the function indicator lamp flashes in green.
2. To turn off the quick hear-through function, press the subswitch button again.
 - You can also turn off the quick hear-through function by long touching (2 seconds) so that your palm covers the upper, center, and lower parts of the touch panel.
 - When the quick hear-through function is on, the touch panel on the main unit can be only operated to turn the function off.



Wired connection (playthrough function)

The product has a playthrough that allows you to use it as portable headphones and play back music even when there is no battery power. You can connect the connector plug of the included cable to the product's connector jack, and then connect the input plug into a portable audio player.

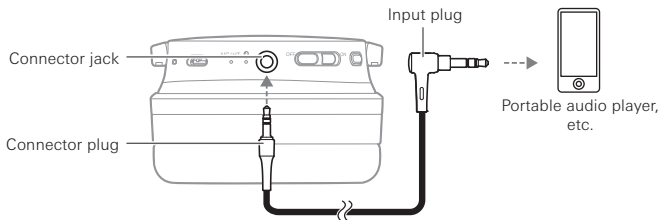

- If there is battery power remaining, you can use ambience control by turning on the product even during a wired connection. In such cases, the touch panel on the main unit can be only operated to switch the ambience control.

Using the product

Reset function

If the product does not work or other malfunctions occur, refer to "Charging the battery" (p.6) for information on inserting the USB charging cable to provide power, and then do a reset.

Disconnecting and then reconnecting the USB charging cable will reset the product and should resolve any problem you are experiencing. If the problem persists, contact your local Audio-Technica dealer.

Resetting does not change any of your settings (pairing information, volume setting, etc.).

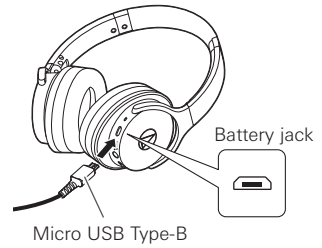

App for smartphones

You can use Audio-Technica's app for smartphones for more convenient use of the product.



CONNECT App
iOS, Android



<https://app.at-globalsupport.com>



Multi-indicator lamp display

The multi-indicator lamp of the product indicates the product's status as explained below.

Status		Multi-indicator lamp display pattern	● Red ○ White
Pairing	Searching for devices	○-○-○-○-○-○-○-○-○- ...	Flashing quickly
Connection	Waiting to be connected	○○-----○○-----○○-----○ ...	Flashing in 4 second intervals
	Connecting	○-----○-----○-----○----- ...	Flashing in 3 second intervals (○: Gradually lights up)
Battery level	Battery level low	White in the pairing or connection status turns red.	
Charge	Charging	 ...	Lit
	Fully charged	----- ...	Off

Voice guidance

The product plays English voice guidance in the following situations.

Situation	Voice guidance
Power is turned on	Power on
Power is turned off	Power off
Bluetooth is connected	Bluetooth connected
Bluetooth is disconnected	Bluetooth disconnected
Battery level is low	Low battery
Noise cancelling is turned on	Noise cancelling
Hear-through is turned on	Hear-through
Ambience control is turned off	Off

Cleaning

Get into the habit of regularly cleaning the product to ensure that it will last for a long time. Do not use alcohol, paint thinners, or other solvents for cleaning purposes.

- To clean, wipe with a dry cloth.
- Wipe away any perspiration or dirt from the cable with a dry cloth immediately after use. Failure to clean the cable may cause it to deteriorate and harden over time, resulting in malfunction.
- Wipe the plug with a dry cloth if dirty. If you use a dirty plug, you may hear distorted or skipping sound.
- Wipe away any dirt from the earpads and headband with a dry cloth. The colors may fade if sweat or water gets on the earpads and headband. In this case, we recommend that you wipe them with a dry cloth and let them dry in a shaded spot.

- If the product will not be used for an extended period of time, store it in a well-ventilated place free from high temperatures and humidity.
- The earpads are consumable parts. They degrade through storage and use, so replace them as early as possible. For earpad replacement and other repairs, contact your local Audio-Technica dealer.

Troubleshooting

Problem	Solution
Power is not supplied.	<ul style="list-style-type: none">• Charge the product.
Unable to pair.	<ul style="list-style-type: none">• Confirm that the Bluetooth device communicates using Ver. 2.1+EDR or higher.• Place the product and the Bluetooth device within 1 m (3.3') of each other.• Set the profiles for the Bluetooth device. For procedures on how to set profiles, refer to the Bluetooth device's user manual.• Remove the pairing information for the Bluetooth device then pair the product with this device again.• Long touch (about 10 seconds) the upper and center parts of the touch panel on the product (p.7). The product will switch to the "searching for devices" pairing state, allowing you to pair with your desired Bluetooth device.• This product may be displayed as "ATH-ANC900BT", "BLE_ATH-ANC900BT", or both in the Bluetooth device while searching. If both are displayed, select "ATH-ANC900BT". If only one is displayed, select that one.
No sound is heard / Sound is faint.	<ul style="list-style-type: none">• Turn on the power of the product and the Bluetooth device.• Turn up the volume of the product and the Bluetooth device.• If the Bluetooth device is set to the HFP/HSP connection, switch to the A2DP connection.• Move away from obstacles between the product and the Bluetooth device, such as people, metal or walls, and place the product and device closer together.• Switch the sound output of the Bluetooth device to the Bluetooth connection.
Sound is distorted / Noise is heard / Sound cuts out.	<ul style="list-style-type: none">• Turn down the volume of the product and the Bluetooth device.• Keep this product away from devices that emit radio waves such as microwaves and wireless routers.• Keep this product away from TVs, radios, and devices with built-in tuners. These devices can also be affected by the product.• Turn off the equalizer settings of the Bluetooth device.• Remove obstacles between the product and the Bluetooth device and place them closer together.• Turn off the aptX codec in the Bluetooth device settings before connecting.
Cannot hear the voice of the caller / Voice of the caller is too quiet.	<ul style="list-style-type: none">• Turn on the power of the product and the Bluetooth device.• Turn up the volume of the product and the Bluetooth device.• If the Bluetooth device is set to the A2DP connection, switch to the HFP/HSP connection.• Switch the sound output of the Bluetooth device to the Bluetooth connection.
The product cannot be charged.	<ul style="list-style-type: none">• Securely connect the included USB charging cable and charge the product.
Sound is delayed (video and audio are out of sync).	<ul style="list-style-type: none">• Refer to "SBC priority connection (for when sound is significantly delayed)" (p.18) and change the connection codec to SBC.
Noise cancelling or hear-through does not seem to work.	<ul style="list-style-type: none">• Confirm that the function indicator lamp is lit green.• Confirm that the product is properly positioned over your ears.• The ambient noise may not match the cancelling frequency.

- For details about how to operate your Bluetooth device, refer to the device's user manual.
- If the problem still remains, reset the product. To reset the product, refer to "Reset function" (p.14) under "Using the product".

Troubleshooting

SBC priority connection (for when sound is significantly delayed)

Significant sound delays may be mitigated by changing the connection codec from AAC to SBC, which is normally included in Bluetooth devices.*1

Connecting

The procedure is performed while the product and Bluetooth device are paired.

1. Turn on the product.
2. With the music paused, long touch (10 seconds) the upper and bottom parts of the touch panel as shown in the figure.
 - The multi-indicator lamp will light in pink once, and then the product will turn off. It will turn on again and be automatically connected to the Bluetooth device.*2
 - When settings are complete, only the SBC connection codec will be available. Other codecs will not be connected.
 - For information about the multi-indicator lamp display, refer to "Multi-indicator lamp display" (p.15).*3

*1 Depending on your usage environment, sound delays may not be mitigated even if you change to SBC priority connection.

*2 If the product is not connected automatically, refer to "Pairing a Bluetooth device" (p.7), and pair again.

*3 When you turn off the product and turn it on again, the connection returns to normal and connection with other codecs is enabled. Perform the SBC priority connection procedure whenever needed.



Specifications

Headphones

Type	Dynamic
Driver	40 mm
Sensitivity	103 dB/mW (when using noise-cancelling function)* ¹ 100 dB/mW (when not using noise-cancelling function)* ¹
Frequency response	5 to 45,000 Hz
Impedance	35 ohms (unit impedance)* ¹

Microphone

Type	Electret condenser
Polar pattern	Omnidirectional
Sensitivity	-44 dB (1 V/Pa, at 1 kHz)
Frequency response	50 to 4,000Hz

Communication specifications

Communication system	Bluetooth version 5.0
RF output	Less than 10 mW EIRP
Maximum communication range	Line of sight - approx. 10 m (33')
Frequency band	2.402 GHz to 2.480 GHz
Modulation method	FHSS
Compatible Bluetooth profiles	A2DP, AVRCP, HFP, HSP
Support codec	Qualcomm® aptX™ audio, AAC, SBC
Supported content protection method	SCMS-T
Transmission band	20 to 20,000 Hz

*¹ During wired connection.

Specifications

Other

Power supply	DC 3.7 V lithium polymer battery
Charging time	Approx. 5.5 hours* ²
Operating time	Continuous transmission time (music playback): Max. approx. 35 hours (when using Bluetooth and noise cancelling)* ² Max. approx. 60 hours (when using noise cancelling only)* ²
Weight	Approx. 263 g (9.3 oz)
Operating temperature	5°C to 40°C (41°F to 104°F)
Accessories	<ul style="list-style-type: none">• USB charging cable (30 cm (12")), USB Type-A / Micro USB Type-B)• Cable (1.2 m/3.5 mm (1/8")) gold-plated stereo mini-plug/L-type)*³• Airplane adapter• Case
Sold separately	<ul style="list-style-type: none">• Cable

*² The figures above depend on operating conditions.

*³ The diameter is 2.5 mm (3/32") on the straight plug side and 3.5 mm (1/8") on the L-shaped plug side.

For product improvement, the product is subject to modification without notice.

- The Bluetooth® word mark and logos are owned by Bluetooth SIG, Inc. and any use of such marks by Audio-Technica Corporation is under license. All other trademarks are property of their respective owners.
- "AAC" logo is a trademark of Dolby Laboratories.
- Qualcomm aptX is a product of Qualcomm Technologies, Inc. and/or its subsidiaries.
Qualcomm is a trademark of Qualcomm Incorporated, registered in the United States and other countries, used with permission.
aptX is a trademark of Qualcomm Technologies International, Ltd., registered in the United States and other countries, used with permission.
- Apple and the Apple logo are trademarks of Apple Inc. registered in the United States and other countries.
- The App Store is a service mark of Apple Inc.
- Google Play and the Google Play logo are trademarks of Google LLC.

